

Tools Required:

- 3mm hex key

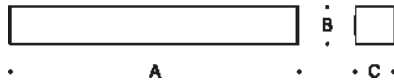

Dimensions

- A: 36-5/8"
- B: 4-1/8"
- C: 4-1/4"



Overview:

LED Watts: 34.8W
 System Watts: 41W
 Controllability: 0-10V dimming down to 1%
 Weight: 19.0 lbs.
 Protection Class: IP65

Notice to Installer for 24 641:

1. See page 2 for specific product safety warnings.
2. For attachment to wall over separate 4" octagonal wiring box (by others).
3. Wiring box needs to be recessed into wall and must be flush with the finished surface.
4. In conformance with UL Standard 1598, a silicone based sealant MUST be used between luminaire and supporting wall.
5. For wall applications only.

24 641 - luminaire installation:

1. Loosen (2) 3mm set screws and remove luminaire mounting plate (Fig. 1).
2. Attach and secure mounting plate to wall using hardware by others.
3. Route luminaire wires through opening in mounting plate. Make supply wiring and luminaire wiring connections inside the 4" wiring box:
 MAIN VOLTAGE SUPPLY WIRE TO BLACK LUMINAIRE WIRE
 NEUTRAL (COMMON) SUPPLY WIRE TO WHITE LUMINAIRE WIRE
 GREEN GROUND WIRE TO GREEN LUMINAIRE WIRE.
 Dimming (if applicable):
 DIMMING CONTROL WIRE (+) TO POSITIVE DRIVER DIM CONTROL WIRE
 DIMMING CONTROL WIRE (-) TO NEGATIVE DRIVER DIM CONTROL WIRE
4. Mount luminaire to mounting plate using (2) 3mm hex screws. Tighten screws evenly (Fig. 1) (Fig. 2).
5. Apply a silicone-based sealant between the installed fixture and the finished wall to prevent water from entering the back box. At a minimum, use silicone on the top and side edges of the fixture (exterior applications only).

Figure 1.

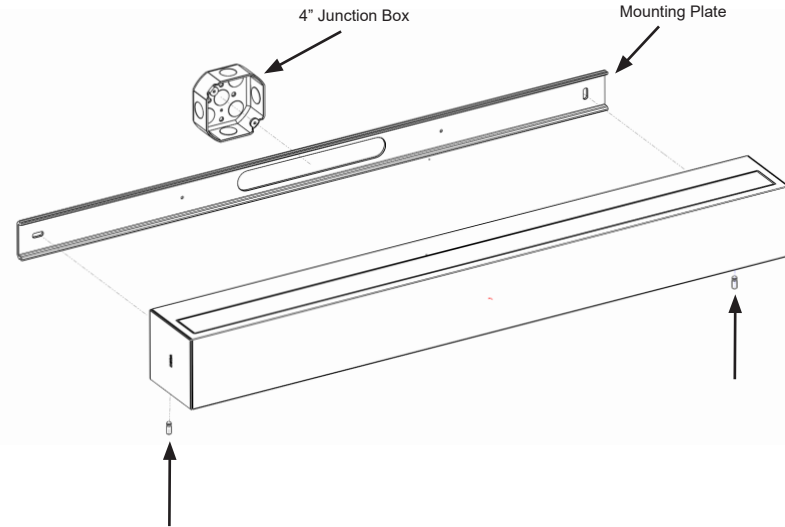
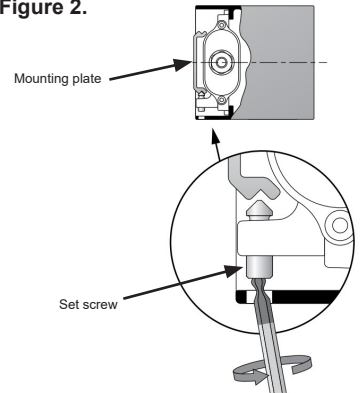

Figure 2.



Accessories

Please refer to the appropriate accessory installation sheet for further instruction when applicable.

Maintenance:

Clean regularly with solvent-free cleaner removing dirt and debris. Do not use high pressure cleaners.

Replacement Parts

See label inside of fixture for LED replacement part number.
 Consult factory for all other replacement components.

Product Safety Warnings:

THIS PRODUCT MUST BE INSTALLED IN ACCORDANCE WITH THE APPLICABLE INSTALLATION CODE BY A PERSON FAMILIAR WITH THE CONSTRUCTION AND OPERATION OF THE PRODUCT AND THE HAZARDS INVOLVED.
SUITABLE FOR WET LOCATIONS.
WALL MOUNT ONLY.
SUITABLE FOR MOUNTING WITHIN 1.2m (4 FT) OF THE GROUND
MIN 60°C SUPPLY CONDUCTORS.

CE PRODUIT DOIT ÊTRE INSTALLÉ SELON LE CODE D'INSTALLATION PERTINENT, PAR UNE PERSONNE QUI CONNAÎT BIEN LE PRODUIT ET SON FONCTIONNEMENT AINSI QUE LES RISQUES INHÉRENTS.
CONVIENT AUX EMPLACEMENTS MOUILLÉS.
INSTALLATION MURALE SEULEMENT
PEUT ÊTRE INSTALLÉ À MOINS DE 1,2 m (4 pi) DU SOL
LES FILS D'ALIMENTATION 60°C MIN.